



**INSTALLATION, MAINTENANCE AND USE
INSTRUCTIONS FOR
FREE-STANDING COOKERS
121,9x64 cm (type MT/MTV)**

**READ THE INSTRUCTION BOOKLET BEFORE INSTALLING AND USING
THE APPLIANCE.**

**The manufacturer will not be responsible for any damage to property or to persons
caused by incorrect installation or improper use of the appliance.**

The manufacturer is not responsible for any inaccuracies, due to printing or transcription errors, contained in this booklet. In addition, the appearance of the figures reported is also purely indicative.

The manufacturer reserves the right to make changes to its products when considered necessary and useful, without affecting the essential safety and operating characteristics.

CONTENTS:

INSTALLER TECHNICAL MANUAL	pg. 2
Installing the cooker - Installation information	pg. 2
Ventilation and aeration of rooms.....	pg. 3
Height adjustable legs	pg. 3
Backguard installation instruct	pg. 3
Gas connection	pg. 3
Adaptation to different types of Gas and burner adjustments.....	pg. 3-4
Electric connection	pg. 4
APPLIANCE MAINTENANCE - Replacing parts.....	pg. 5
USE AND MAINTENANCE MANUAL	pg. 5-6
Description of control panel and control types.....	pg. 6
Using burners.....	pg. 6
Using the electric griddle	pg. 6-7
Using the electric thermostat.....	pg. 7
Using the 9+0 switch.....	pg. 7
Using the thermostat with switch in series.....	pg. 8
Using the natural conventional electric oven	pg. 8
Using the ventilated electric oven.....	pg. 9
Using the electric grill	pg. 9
Using the ventilated electric grill.....	pg. 10
Using the self cleaning oven	pg. 10
Cleaning the appliance.....	pg. 10
After-sales technical service and spare parts.....	pg. 10

THIS APPLIANCE HAS BEEN DESIGNED FOR NON-PROFESSIONAL DOMESTIC USE.

INSTALLER TECHNICAL MANUAL



This appliance is marked according to the European directive 2002/95/EC

This appliance is marked according to the European directive 2002/96/EC on Waste Electrical and Electronic Equipment (WEEE).

This guideline is the frame of a European-wide validity of return and recycling on Waste Electrical and Electronic Equipment.

INSTALLER INFORMATION

The installation, all adjustments, transformations and maintenance listed in this part of the manual must be carried out only by skilled personnel.

Improper installation may cause damage to persons, animals or property, for which the manufacture will not be held responsible.

The appliance safety or automatic adjustment devices may be changed during the service life of the system only by the manufacturer or by the duly authorised supplier.

INSTALLING THE COOKER

After having removed the various loose parts from the internal and external packing, make sure that the cooker is not damaged. In case of doubt, do not use the appliance and contact skilled personnel.

Keep all the dangerous packing parts (polystyrene foam, bags, cardboard, staples, etc.) away from children.

The appliance can be installed as a freestanding unit, next to a wall at a distance of no less than 20mm (Fig.2, Class 1 Installation) or inserted between two walls (Fig.1, Class 2 Subclass 1 Installation). A single sidewall that exceeds the height of the work surface is possible. This must be at a minimum distance of 70 mm from the edge of the cooker (Fig.2, Class 1 Installation)

Any walls of the adjacent furniture pieces and the wall behind the cooker must be made with heat-resistant material that can withstand a minimum overtemperature of 65 K.

The appliance can be installed as class 1 and as class 2 subclass 1.

WARNING: when the appliance is installed as class 2 subclass 1, the connection to the gas network must only use metal flexible pipes that conform with the national standards in force.

IMPORTANT INFORMATION FOR INSTALLING THE APPLIANCE

The cooker can be installed separately, as a freestanding unit, or between kitchen units or between a kitchen unit and the wall. The device must be installed in accordance with the regulations stated in UNI 7129 and UNI 7131 standards.

This appliance is not connected to devices which exhaust combustion products.

Special attention must be focused on the prescriptions described below regarding room aeration and ventilation. Any hanging cabinets installed above the work surface must be located at a distance of no less than 700 mm.

ROOM VENTILATION

To ensure that the appliance operate correctly, the room where it is installed must be continuously ventilated. The room volume should not be less than 25 m³ and the quantity of air needed shall be based on the regular combustion of gas and on the ventilation of the room. Natural air will flow through permanent openings in the walls of the room to be ventilated: these openings will be connected with the outside environment and shall have a minimum cross-section defined by the current national standards regarding room ventilation (see Fig. 3).

These openings shall be built so that they cannot be clogged.

Indirect ventilation is also permitted by taking air from the rooms adjacent to the one to be ventilated.

LOCATION AND AERATION

The gas cooking appliances must always evacuate the combustion products by means of hoods connected to chimneys, flues or directly outside (see Fig. 4). If a hood cannot be installed, it is possible to use a fan installed on a window or directly facing outdoors, to be operated together with the appliance (see Fig. 5), provided that there is strict compliance with the ventilation regulations.

HEIGHT ADJUSTABLE LEGS (Fig.6)

Legs are packed in the top box.

Legs should be installed with the appliance being near the location of final installation, they are not secure for long transport. After unpacking the range, raise it about a foot to insert the legs in their bases assembled on the lower part of the cooker and lower the range gently to keep any undue strain from legs and mounting hardware. It is recommended to use a pallet or lift jack instead of tilting the unit.

BACKGUARD INSTALLATION INSTRUCTION

- 1) Remove n°2 screws fixing worktop as shown in fig.7
- 2) Place front part of the backguard and attach it from bottom side with the two removed screws (point 2) as shown in fig .8
- 3) Fix the front part of the backguard with the screws supplied with the backguard kit (fig.9)
- 4) Assemble back part with front part of the backguard and fix them with a screws supplied with the backguard kit (fig.10)

APPLIANCE GAS CONNECTION

Before connecting the appliance to the gas network, make sure that the data on the label attached to the food warmer drawer or on the back of the cooker are compatible with what is indicated for the gas distribution network.

A label attached to the last page of this handbook and in the food warmer drawer (or on the back) of the appliance indicates the appliance adjustment conditions: type of gas and operating pressure.

IMPORTANT: This appliance must be installed in compliance with current national standards in force and used only in a well-ventilated room.

WARNING: It should be recalled that the appliance utilises a threaded 1/2" gas cylindrical male fitting according to UNI-ISO 228-1.

To connect the appliance to the gas network with a flexible rubber hose, a supplemental hose nipple fitting is needed (see Fig. 11) which is supplied with the appliance.

ADAPTATION TO DIFFERENT TYPES OF GAS FOR COOKER TYPE M6V

Before performing any maintenance operation, disconnect the appliance from the gas supply and electricity network.

REPLACING THE NOZZLES TO OPERATE WITH ANOTHER TYPE OF GAS FOR COOKER TYPE M6V:

Follow the instructions below to change the burner nozzles on the work surface:

- 1) Pull out the plug from the electric outlet to avoid any type of electric contact.
- 2) Remove the grids from the work surface.
- 3) Remove the burners.
- 4) Unscrew the nozzles using a 7 mm spanner, and replace them (Fig.12) with those needed for the new type of gas according to what is indicated in Table 1.

WARNING: After completing the above-mentioned replacements, the technician must adjust the burners, as described in the paragraph below, seal any adjustment and pre-adjustment devices and apply the label on the appliance, to replace the existing one, corresponding to the new gas adjustment. This label is contained in the spare nozzle bag.

TABLE N°1: Adaption to various types of gas

APPLIANCE CATEGORY: II2H3+

Burner	Types of Gas	Pressure	Nozzle Diameter	Rater Capacity				Reduced Capacity		by-pass Diameter
		mbar	1/100 mm.	g/h	l/h	kw	kcal/h	kw	kcal/h	1/100 mm.
Auxiliary	Natural G20	20	72	-	95	1	860	0,48	413	34 reg.
	Butane G30	30	50	73	-	1	860	0,48	413	34
	Propane G31	37	50	71	-	1	860	0,48	413	34
Semi-Rapid	Natural G20	20	97	-	167	1,75	1505	0,6	516	36 reg.
	Butane G30	30	65	127	-	1,75	1505	0,6	516	36
	Propane G31	37	65	125	-	1,75	1505	0,6	516	36
Rapid	Natural G20	20	115	-	286	3	2580	1,05	903	52 reg.
	Butane G30	30	85	218	-	3	2580	1,05	903	52
	Propane G31	37	85	214	-	3	2580	1,05	903	52
Dual Inner	Natural G20	20	72	-	95	1	860	0,48	413	34 reg.
	Butane G30	30	46	73	-	1	860	0,48	413	34
	Propane G31	37	46	71	-	1	860	0,48	413	34
Dual Outer	Natural G20	20	102	-	334	3,5	3010	1,8	1548	65 reg.
	Butane G30	30	66	254	-	3,5	3010	1,8	1548	65
	Propane G31	37	66	250	-	3,5	3010	1,8	1548	65

BURNER ADJUSTMENT

2) Burner "MINIMUM" adjustment:

Work surface burner adjustment: follow the instructions below to adjust the work surface burner minimum:

- 1) Light the burner and set the knob to the MINIMUM position (small flame).
- 2) Remove the knob of the valve that is press fit on the rod of that valve.
- 3) If the cooker is not equipped with safety valves on the surface burners, insert a small slotted screwdriver into the hole on the valve rod (Fig. 13) and turn the choke screw to the right or left until the burner flame is adjusted to minimum. If the cooker is equipped with safety valves, the choke valve is not located in the rod hole, but on the valve body (see fig. 14).
- 4) Make sure that the flame does not go out when switching quickly from the MAXIMUM to the MINIMUM position.

WARNING: The above-mentioned adjustment should be made only with methane gas burners, while for those operating with liquid gas the screw must be locked at the end in a clockwise direction. The grill burner always operates at maximum and therefore no minimum adjustment is required.

APPLIANCE ELECTRIC CONNECTION:

The electric connection must comply with the current legal standards and regulations.

Before making the connection, check that:

- The system electrical rating and the current outlets are adequate for the maximum power output of the appliance (see the label applied to the bottom of the casing).
- The outlet or the system is equipped with an efficient ground connection in accordance with the current legal standards and regulations. The company will not be responsible for the non-compliance with these instructions.

When the connection to the power supply network is made using an outlet:

- If the power cord is supplied without a plug, apply a standard plug that is suitable for the load indicated on the label. Connect the wires according to the diagram shown in FIG.15 and check that:

letter L (phase) = brown wire;

letter N (neutral) = blue wire;

ground symbol \perp = green-yellow wire;

- The power cord must be positioned so that an overtemperature of 75 K will not be reached at any point.
- Do not use reductions, adapters or splitters since they might cause false contacts and lead to dangerous overheating.

When the connection is made directly to the electric network:

- Use a device that ensures disconnection from the mains in which the contacts are opened to a distance that permits complete disconnection according to the conditions for over-voltage category III.
- Remember that the ground wire must not be interrupted by the circuit-breaker.
- As an alternative, the electric connection can also be protected by a high-sensitivity residual current circuit-breaker.
- It is highly recommended to attach the special green-yellow ground wire to an efficient ground system.

WARNING: If the power cord is replaced, the ground wire (yellow-green) connected to the terminal, should be longer than the other wires by about 2 cm.

TABLE N°2 : TYPES OF POWER CORDS

Work surface operation	Oven operation	Cross section
Gas burner and electric griddle	Ventilated Electric Oven Left Conventional Electric Oven Right	H057RN-F 3x4mm ²

ATTENTION: The appliance conforms with the regulations of directives 90/396EEC (Gas Directive) regarding gas appliances for domestic use and the like, 73/23 (Low Voltage Directive) regarding electrical safety and 2004/108/CE, (EMC Directive) regarding electromagnetic compatibility.

APPLIANCE MAINTENANCE

ATTENTION: IMPORTANT WARNINGS

For cookers resting on a base

ATTENTION: If the cooker rests on a base, take the measures necessary to prevent the cooker from sliding along the support base.

For cookers with glass covers

ATTENTION: Before opening the appliance's glass cover, carefully remove all liquid residues from the top of it.
ATTENTION: Before closing the appliance's glass cover, make sure that the work surface has cooled.

For cookers with electric ovens

The unit becomes hot during use. Do not touch the heating elements inside the oven.

For cookers with electric ovens

ATTENTION: The accessible parts can become hot during use. Keep children away from the appliance.

For the food warmer compartment (or drop leaf in our case)

ATTENTION: The internal parts of the food warmer can become hot during use.

For glass doors

Do not use abrasive cleaning products or metal spatulas with sharp edges to clean the oven door's glass since this could scratch the surface and the glass could break.

Do not use steam cleaners to clean the appliance.

REPLACING PARTS

Before performing any maintenance operation, disconnect the appliance from the gas supply and electricity network.

To replace parts such as knobs and burners, just remove them from the seats without disassembling any part of the cooker.

To replace parts such as nozzle supports, valves and electric components follow the procedure described in the burner adjustment paragraph. To replace the valve or the gas thermostat, it is also necessary to disassemble the two rear gas train brackets, loosening the 4 screws (2 per bracket) that attach it to the rest of the cooker and, unscrew the nuts that attach the front burner valves to the control support, after removing all the knobs. To replace the gas or electric thermostat, also disassemble the rear cooker guard, loosening the relative screws, to be able to pull out and reposition the thermostat bulb.

To replace the oven bulb, just unscrew the protection cap that projects out inside the oven. (Fig.16)

WARNING: Before replacing the bulb, disconnect the appliance from the electric power supply.

WARNING: The power cord supplied with the appliance is connected to that appliance with an **X** type connection (in compliance with standards EN 60335-1, EN 60335-2-6 and subsequent amendments) for which it can be installed without the use of special tools, with the same type of cord as the one installed.

If the power cord becomes worn or damaged, replace it based on the information reported in table 2 .

WARNING: If the power cord is replaced, the installer shall ensure that the ground cable is longer than the phase cables and also shall comply with the warnings regarding the electric connection.

To replace the power cable, lift the terminal board's cover and replace the cable. To access the terminal board in cookers with a 3x4mm² cable, the back panel on the rear of the appliance must be removed.

USE AND MAINTENANCE MANUAL

Table 3 GAS BURNER DIMENSION (fig.17)

Burner	Dimension (mm)
Auxiliary	Ø 50
Semi-rapid	Ø 70
Rapid	Ø 95
Dual	Ø 140

CONTROL PANEL DESCRIPTION

On the control panel, small symbols show the function of each knob or key. Here as follows are the several controls that a cooker can have:

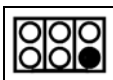

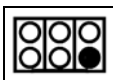
the symbol  shows the disposition of burners on the worktop, the full dot identifies the burner in object (in this case the front burner on the right).

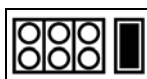

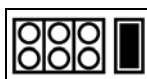
the symbol  shows the disposition of burners and the griddle on the worktop, the full dot identifies the element in object (in this case the electric griddle).

the symbol  shows the running of left or right oven (conventional electric for right oven, 9 positions switch for left oven)

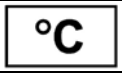
the symbol  shows the electric thermostat for electric left oven

USING BURNERS

A diagram is etched on the control panel above each knob which indicates which burner corresponds to that knob. The burners can be ignited in different ways depending on the type of appliance and its specific characteristics:

- **Manual lighting (it is always possible even when the power is cut off):** Turn the knob anticlockwise that corresponds to the burner selected, setting it to the MAXIMUM position at the etched star (large flame Fig.18) and place a lit match up to the burner.

- **Electric ignition:** Turn the knob counterclockwise that corresponds to the burner selected, setting it to the MAXIMUM position (large flame Fig. 18) and keep on pressing the knob in correspondence of the ignition symbol marked with a star (for cookers equipped with ignition trough knob) or press the ignition button marked with a star and release it as soon as the burner has ignited.

- **Burner ignition equipped with safety device (thermocouple)(fig.19):** Turn the knob anticlockwise that corresponds to the burner selected, setting it to the MAXIMUM position at the etched star (large flame Fig. 18), press the knob and activate one of the above-mentioned ignition devices. Once ignited, keep pressing the knob for about 10 seconds to allow the flame to heat the thermocouple. If the burner goes out after releasing the knob, repeat the entire operation.

Note: It is recommended not to try to ignite a burner if the relative flame cap is not in the correct position.

Tips for using burners correctly:

- Use suitable pots for each burner (see tab. 4 and Fig. 20).
- When the liquid is boiling, turn the knob to the MINIMUM position (small flame Fig. 18).
- Always use pots with a cover.

TABLE N°4

BURNER	PAN DIAMETER recommended (cm)
Auxiliary	12-14
Semi-rapid	14-26
Rapid	18-26
Dual	22-26

ATTENTION: Use pots with a flat bottom

WARNING: If the power is cut off, the burners can be lit with matches. When cooking foods with oil and fat, which are very flammable, the user should not leave the appliance unattended. If the appliance is equipped with a glass cover, such a cover may break when heated. Turn off all burners before lowering the cover. Do not use sprays near the appliance when it is being used. When using the burners, make sure that the handles of the pots are correctly positioned. Keep children away from the appliance. If equipped with a cover, before being closed, any food deposits should be cleaned off the built-in surface.

NOTE: The use of a gas cooking appliance produces heat and humidity in the room where it is installed. Therefore, proper aeration in the room is needed while ensuring that natural ventilation openings remain unobstructed (Fig.3) and activating the mechanical aeration device/exhaust hood or electric fan (Fig. 4 and Fig. 5). Intensive and continuous use of the appliance may require additional aeration, for example by opening a window, or more efficient aeration by increasing the power of the mechanical exhauster, if installed.

USING THE ELECTRIC GRIDDLE

WARNING

The griddle element is hot after use. Allow sufficient time for griddle components cool before cleaning.

The power of the electric griddle oven is 1100W.

Seasoning the griddle

Before using the griddle for the first time, it must be seasoned.

If the griddle has not been used for a period of time, it should be reseasoned.

To season the griddle:

1. clean the griddle thoroughly with hot, soapy water to remove any protective coating.
2. rinse with a mixture of 1 quart water and 1 cup white vinegar. Dry thoroughly.
3. Pour 1 teaspoon vegetable oil into the center of the griddle. Do not use corn oil as it gets sticky. Rub the oil over the entire surface of the griddle using a heavy cloth.
4. Turn the control knob to a maximum setting (7) (fig.21). Turn the heat off when the oil begins to smoke. Allow the griddle to cool.
5. Repeat step 3. Be sure to cover the entire surface with the oil
6. Repeat step 4. Allow the griddle to cool. Wipe the entire surface of the griddle using a heavy cloth. Apply a very thin layer of vegetable oil. The griddle is now ready to use.

Use

Press and turn the knob anti-clockwise to the selected position

Pre-heat at the maximum temperature, (7 position) for 15 minutes, then place the food on the griddle and cook to the desired temperature.

The activation of the griddle is shown by the indicator light which is also found on the front panel of the appliance.

Table 5 Griddle cooking recommendations

FOOD	KNOB POSITION	SETTING
Eggs	5-6	150°C to 160°C
Bacon; Breakfast Sausage	6	177°C to 190°C
Toasted Sandwiches	5-6	160°C to 177°C
Boneless Chicken Breasts	6	177°C to 190°C
Boneless Pork Chops (15mm thick)	6	177°C to 190°C
Ham Slices (15mm thick)	6	177°C to 190°C
Pancakes; French Toast	6	177°C to 190°C
Potatoes; Hash Browns	7	190°C to 205°C

USING THE ELECTRIC THERMOSTAT (Left oven)

The thermostat supplied with the relative models maintains a constant temperature inside the oven at a specific temperature setting ranging from 50°C to 250°C.(fig.23)









Turn the knob clockwise and align the selected temperature indicated on the ring with the index etched on the control panel. Thermostat operation is indicated by an orange light which will turn off when the temperature inside the oven is 10°C greater than the temperature setting, and will turn on when the oven is 10°C less than the temperature setting. The thermostat can control the oven elements only if the relative switch is in one of the possible oven element operating modes: if the switch is in position 0, the thermostat has not effect on the oven elements, which remain off.

USING THE 9 + 0 SWITCH (Left oven)

The 9 + 0 switch installed in the multifunction oven models is used, along with the thermostat, to control the electric fan and the oven elements since they can be turned on by turning the 9 + 0 switch knob and the thermostat knob. Turning just one of the two knobs will not have any effect on the oven except to turn on the oven light or the electric fan when inserted. The electric oven is heated by 4 elements: one on the bottom, two on the top or one circular; turning the switch knob (fig.24) turns on the element relative to the symbol indicated on the ring but to be activated the thermostat knob must be turned until the orange light turns on indicating that the element has been turned on. Placing the switch knob on any of the nine operating modes turns on the oven light, together with the relative element. Once the temperature and the elements to be used have been set, the oven elements are turned on and off by the thermostat; therefore, it is normal for the orange light to turn on and off while the oven is working.

To turn off the electric oven set the switch knob to position 0 to prevent the thermostat from controlling the elements. Setting the thermostat knob to position 0 turns off the elements but it is still possible, using the switch, to turn on the electric fan and the oven light.



The switch has 9 different fixed positions corresponding to 9 different types of oven operation:

- the symbol  indicates that only the oven light is turned on;
- the symbol  indicates that the bottom element (1600W) and the top external element (1200W) have been turned on;
- the symbol  indicates that only the top external element (1200W) has been turned on;
- the symbol  indicates the only the bottom element (1600W) has been turned on;
- the symbol  indicates that only the grill element (1800W) has been turned on;
- the symbol  indicates that the top external element (1200W) and the grill element (1800W) have been turned on;
- the symbol  indicates that the top external element (1200W), the grill element (1800W) and the electric fan have been turned on;
- the symbol  indicates that the circular element (2800W) and the electric fan have been turned on;
- the symbol  indicates that only the electric fan has been turned on.

When the knob is set to one of these nine positions, the oven light is always on, thus indicating that the oven is being energised.

**USING THE THERMOSTAT WITH SWITCH IN SERIES (Right oven)
(COOKERS WITH A SINGLE-CONTROL CONVENTIONAL ELECTRIC OVEN)**

The electric oven is controlled by an electric thermostat combined with a switch used to turn on the elements. The electric oven can be combined with an electric grill. The oven is heated by 2 elements: one on the top and one on the bottom. Turning the knob clockwise (fig.25) in the first position we have the single operation of the oven light . Turns on the bottom element and the top external elements while the thermostat is used to set the temperature ranging from 50°C to 250°C. It can be adjusted using the scale indicated on the ring around the knob. An orange light turns off indicating that the temperature setting has been reached. Therefore, it is normal for this light to turn on and off while the oven is working. There are 3 fixed position beyond the 250°C setting:

- the symbol  indicates the only the bottom element (900W) has been turned on;
 - the symbol  indicates that only the top external element (900W) has been turned on;
 - the symbol  indicates that only the grill element (1100W) has been turned on;
- In these positions the temperature is not controlled by the thermostat.

USING THE NATURAL CONVENTIONAL ELECTRIC OVEN 

When using the oven for the first time it should be operated for a maximum of 30 minutes at a temperature of about 250° to eliminate any odours generated by the internal insulation. During normal oven use, select the desired cooking temperature using the thermostat knob and wait until the orange light turns off before putting in any food. The oven is equipped with 4 guides at different heights (fig.22) which can be used to insert shelves or the tray. To keep the oven as clean as possible it is recommended to cook meat on the tray or on the shelf that has been inserted inside the tray. Table No. 6 below lists the cooking times and the position of the tray for different types of foods. Personal experience will help to determine any variations in the values reported in the table. In any case, it is recommended to follow the instructions of the specific recipe being used.

TABLE N°6

NATURAL CONVENTIONAL ELECTRIC OVEN COOKING TABLE			
	TEMP °C	HEIGHT	MINUTES
MEAT			
PORK ROAST	225	3/4	60-80
BEEF ROAST (YOUNG STEER)	225	3/4	60-80
BEEF ROAST	250	3/4	50-60
VEAL ROAST	225	3/4	60-80
LAMB ROAST	225	3	40-50
ROAST BEEF	230	3/4	50-60
ROAST HARE	250	3/4	40-50
ROAST RABBIT	250	3	60-80
ROAST TURKEY	250	3	50-60
ROAST GOOSE	225	3	60-70
ROAST DUCK	250	3/4	45-60
ROAST CHICKEN	250	3/4	40-45
FISH			
	200-225	2	15-25
PASTRY			
FRUIT PIE	225	2	35-40
TEA CAKE	175-200	2	50-55
BRIOCHES	175-200	2	25-30
SPONGE CAKE	220-250	2	20-30
RING CAKE	180-200	2	30-40
SWEET PUFF PASTRIES	200-220	2	15-20
RAISIN LOAF	250	2	25-35
STRUDEL	180	2	20-30
SAVOIA COOKIES	180-200	2	40-50
APPLE FRITTERS	200-220	2	15-20
SAZOIARDI SANDWICH	200-220	2	20-30
TOAST SANDWICH	250	3	5
BREAD	220	3	30
PIZZA	220	2	20

USING THE VENTILATED ELECTRIC OVEN (Left oven)

When using the oven for the first time it should be operated for a maximum of 30 minutes at a temperature of about 250° to eliminate any odours generated by the internal insulation.

Before cooking, allow the oven to reach the desired temperature setting waiting for the orange light to turn off. This type of oven is equipped with a circular element around which a fan has been installed that creates forced-air circulation in the horizontal direction. Thanks to this type of operation, the ventilated oven can be used for different types of cooking at the same time, without changing the taste of each food. Only some models are equipped with a removable metallic filter applied to the rear screen which collects the fat while a roast is cooking. Therefore, it is recommended to remove this fat periodically, washing the screen with soapy water and rinsing thoroughly. To remove the metallic filter just apply slight pressure toward the top on the tab indicated by the arrow. Hot-air circulation guarantees a uniform distribution of heat. Pre-heating the oven is not necessary, but for very delicate pastries, it is recommended to heat the oven before inserting the trays.

The ventilated conventional system partially changes the various notions about traditional cooking. Meat no longer needs to be turned while it is cooking and the rotisserie is no longer needed to cook a roast on the spit. Just put the meat directly on the shelf.

TABLE N°7

VENTILATED ELECTRIC OVEN COOKING TABLE			
	TEMP °C	HEIGHT	MINUTES
MEAT			
PORK ROAST	160-170	2	70-100
BEEF ROAST (YOUNG STEER)	170-180	2	65-90
BEEF ROAST	170-190	2	40-60
VEAL ROAST	160-180	2	65-90
LAMB ROAST	140-160	2	100-130
ROAST BEEF	180-190	2	40-45
ROAST HARE	170-180	2	30-50
ROAST RABBIT	160-170	3	80-100
ROAST TURKEY	160-170	3	160-240
ROAST GOOSE	160-180	3	120-160
ROAST DUCK	170-180	2	100-160
ROAST CHICKEN	180	2	70-90
FISH			
	160-180	2-3	
PASTRY			
FRUIT PIE	180-200	2	40-50
TEA CAKE	200-220	2	40-45
BRIOCHEs	170-180	2	40-60
SPONGE CAKE	200-230	2	25-35
RING CAKE	160-180	2	35-45
SWEET PUFF PASTRIES	180-200	2	20-30
RAISIN LOAF	230-250	2	30-40
STRUDEL	160	2	25-35
SAVOIA COOKIES	150-180	2	50-60
APPLE FRITTERS	180-200	2	18-25
SAZOIARDI SANDWICH	170-180	2	30-40
TOAST SANDWICH	230-250	3	7
BREAD	200-220	3	40
PIZZA	200-220	2	20

USING THE CONVENTIONAL ELECTRIC GRILL

The electric grill can also be combined with the gas oven or electric oven.

In both cases, the grill is controlled using the oven's temperature knob (see also, Using the gas or electric oven). Like the gas grill, the electric grill can be used for grilling on the oven's grill. The static electric grill must be used with the door closed. The temperature set on the thermostat (when present) must not exceed 150°C.

Grilling on the shelf: In this case, the shelf supplied is placed on level 1 or 2 and the foods to be grilled are placed on top, while the tray is inserted on the lower levels to collect the cooking juices. Then turn on the grill element switching the thermostat to the relative position (electric oven version).

WARNING: the accessible parts may become very hot while grilling. Keep children away from the appliance while cooking.

USING THE VENTILATED ELECTRIC GRILL (Left oven)

The ventilated electric grill is a special function equipped only on the multifunction oven. Set the 9 + 0 switch to the relative position to activate the grill element and the electric fan. Generally, to ensure excellent grilling, place the oven shelf in the middle position while the oven tray should be inserted at the bottom.

IMPORTANT: When using the ventilated electric grill, set the thermostat knob no higher than 175 °C, which is between the 150 °C and 200 °C setting, to avoid overheating the front of the appliance. In fact, ventilated grilling must be carried out with the door closed.

Note:

The cooker is equipped with the cooling fan that starts operation each time the oven knob is on a position different from 0 (zero). The fan circulates the air between the control panel and the oven door and also allows the control panel and the oven door stay at a warm temperature during the appliance operation in any condition.

USING THE SELF-CLEANING OVEN

In the cookers where this feature is foreseen, the self-cleaning oven differs from the standard one for the fact that its internal surfaces are enamelled with a special microporous material which absorbs and eliminates the greasy particles during the cooking. In case of spillage of greasy liquids, the self-cleaning action becomes not efficient, therefore it will be necessary to clean the oven properly. Proceed in the following way: (a) wipe a humid sponge on the grease stains; (b) heat up the oven to the maximum temperature; (c) wait 5 minutes and then switch off the oven; (d) wait until the oven gets cool again; (e) wipe again the humid sponge on all the surface. Do not use detergent in any case.

CLEANING THE APPLIANCE

Before cleaning the appliance, it should be disconnected from the power supply and turn off the main gas feeder valve.

Cleaning the work surface:

Periodically clean the burner heads, the enamelled steel grids, the enamelled covers and the flame caps using warm soapy water. Then those parts should be rinsed and thoroughly dried.

Any liquid that overflows from pots must always be removed using a rag.

If it becomes difficult to open or close a valve, do not force it, but immediately request the assistance of the technical service personnel.

Cleaning the enamelled parts:

To maintain the original features of the enamelled parts they should be cleaned frequently with soapy water. Never use abrasive powders. Do not leave acidic or alkaline substances on the enamelled parts (vinegar, lemon juice, salt, tomato sauce, etc.) and do not wash the enamelled parts while they are still hot.

Cleaning the STAINLESS steel parts:

Clean the parts with soapy water and then dry them with a soft cloth. The shine is maintained by periodically using special products that generally are found in the market. Never use abrasive powders.

Cleaning the burner flame caps:

Since the flame caps are resting on the burner, to clean them just remove them from their seat and wash them with soapy water. After they have been thoroughly dried and having checked that the holes are not clogged, they can be replaced in their proper position.

Cleaning the griddle:(fig.26) Thoroughly clean the griddle of grease and food particles, using a square-edged spatula, while it is still hot. Remove drip tray and discard grease into a grease resistant container for disposal. Wash drip tray with hot soapy water, rinse and dry. Wipe the griddle with a dry, heavy, coarse cloth to remove any remaining residue and food particles. Wash with hot soapy water, rinse and dry. Once the griddle has cooled, rub the surface lightly with vegetable oil. Do not use corn oil or cooking sprays as they get sticky. If the griddle is cleaned with anything other than a dry, heavy, coarse cloth, it will need to be reseasoned. Never flood the hot griddle with cold water. This could cause the griddle to crack or warp.

Cleaning the inner glass door: Clean the glass with warm soapy water using a sponge. A spatula can be used to remove burner fat if used gently.

ATTENTION: while cleaning the door make sure to avoid any spillage in the venting holes on the top part of the door. To clean inside the door it is necessary to disassemble the door through a service engineer.

ATTENTION: for further details about cleaning of the appliance, please contact your appliance retailer.

AFTER-SALES TECHNICAL SERVICE AND SPARE PARTS

Before leaving the factory, this appliance was tested and calibrated by skilled and qualified personnel.

Any repairs or calibration that may become necessary after leaving the factory should be performed by skilled personnel. For this reason we advise the customer to contact the Dealer that sold the appliance or the nearest Service Centre, providing them with information about the type of appliance and the type of problem that has occurred. If defective parts must be replaced, it is recommended to replace them with original spare parts that are available only in our technical Service Centres and authorised dealers.

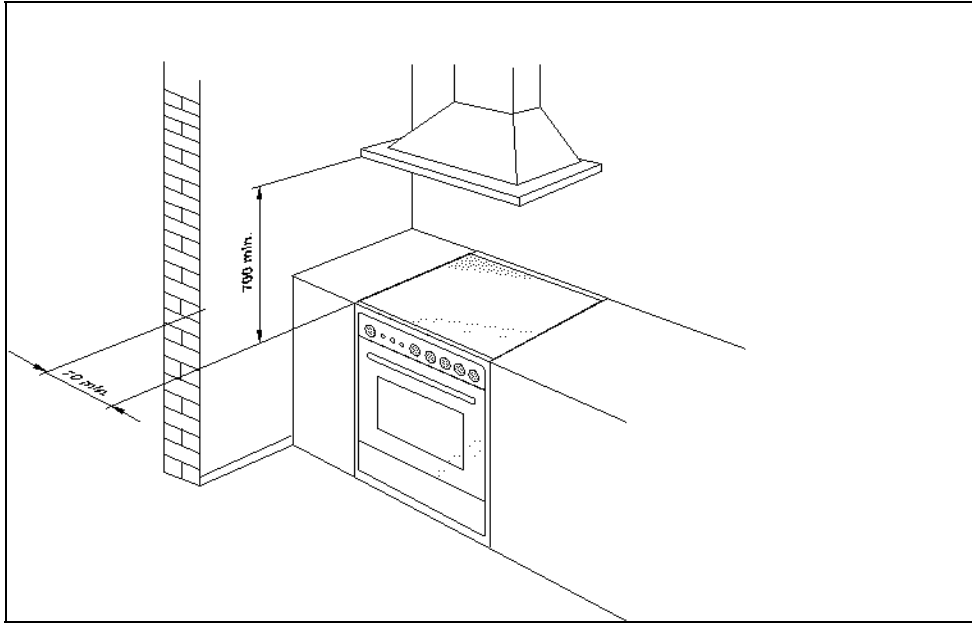

Fig. 1

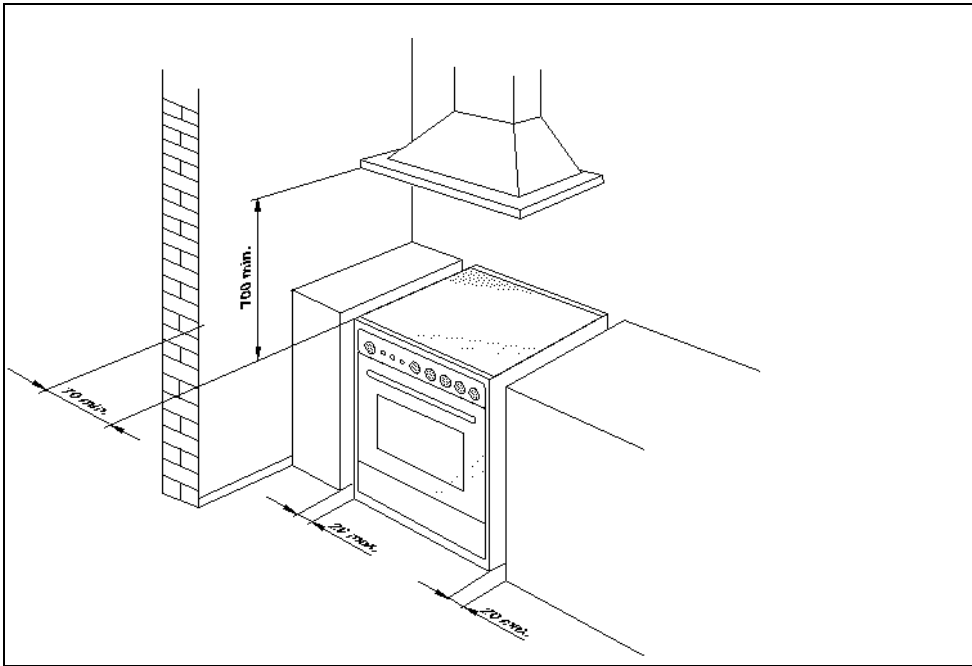

Fig. 2

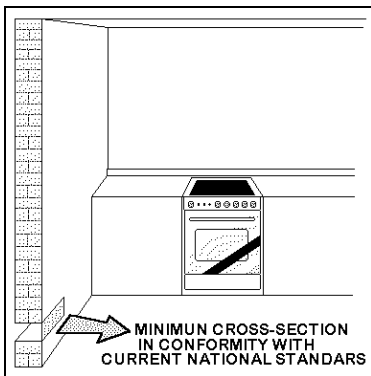

Fig. 3

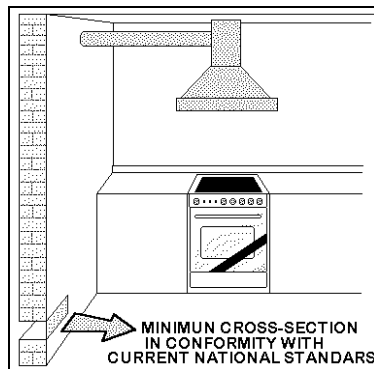

Fig. 4

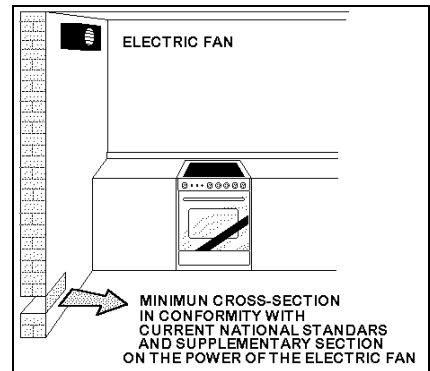

Fig. 5

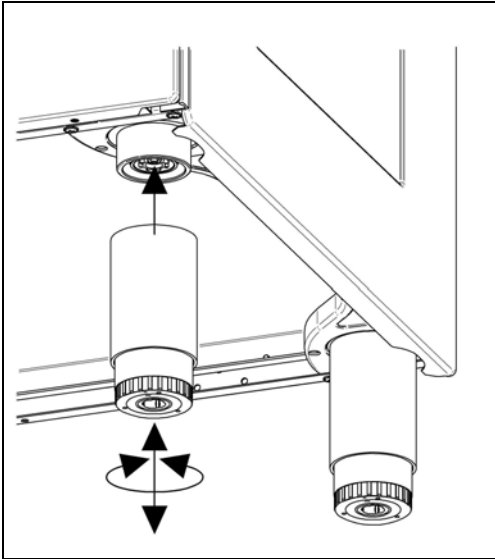

Fig.6

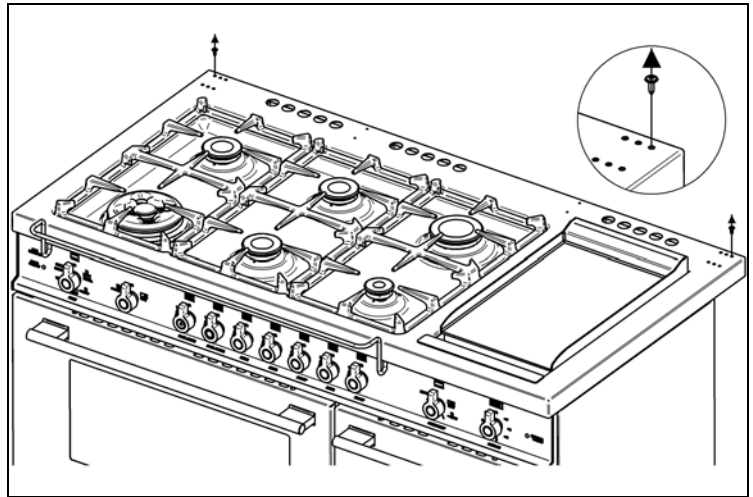

Fig.7

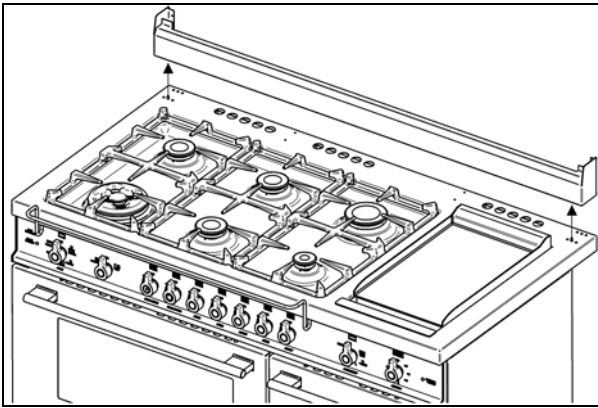

Fig.8

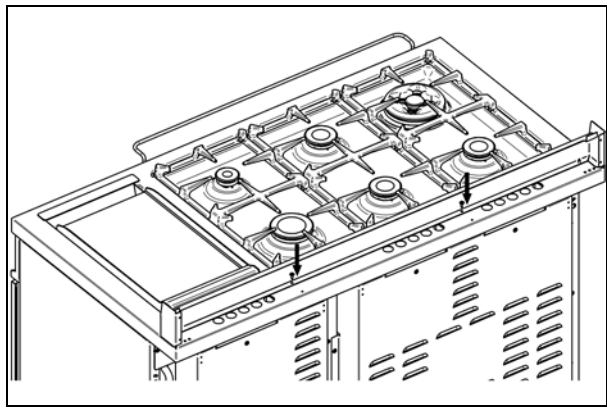

Fig.9

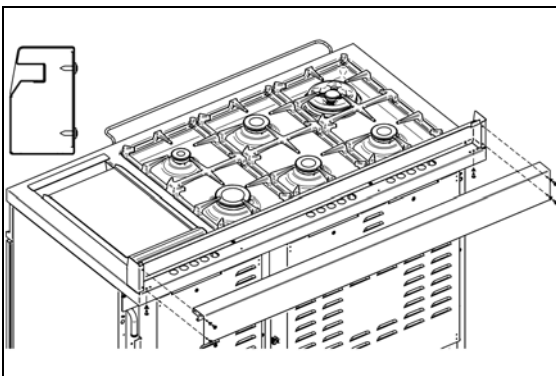

Fig.10

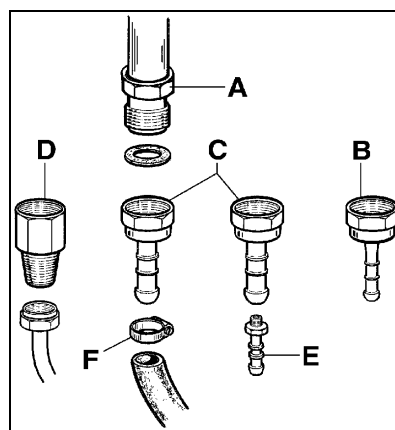

Fig.11

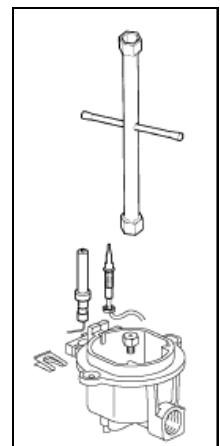

Fig.12

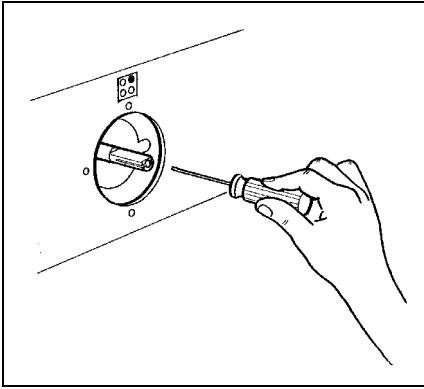

Fig. 13

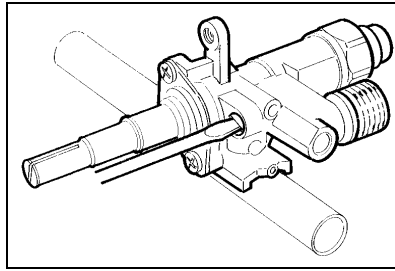

Fig. 14

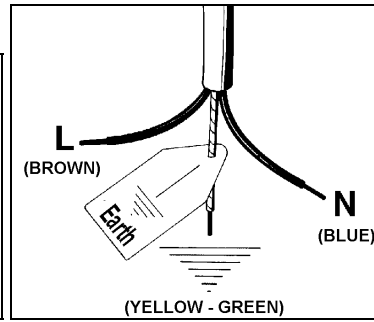

Fig. 15

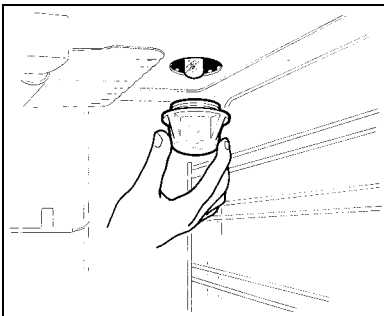

Fig. 16

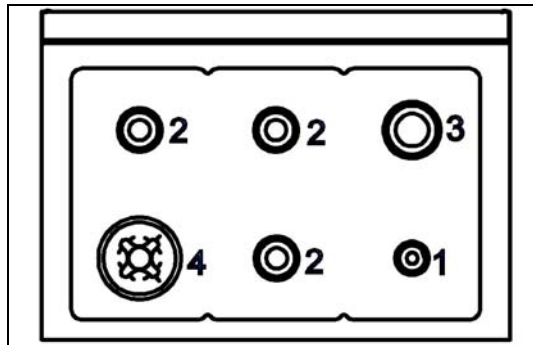

Fig. 17

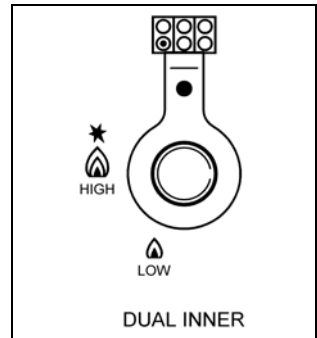

Fig. 18

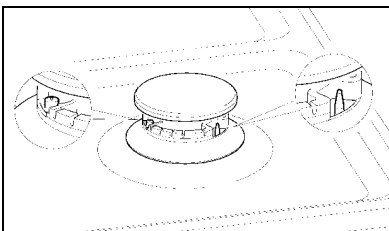

Fig. 19

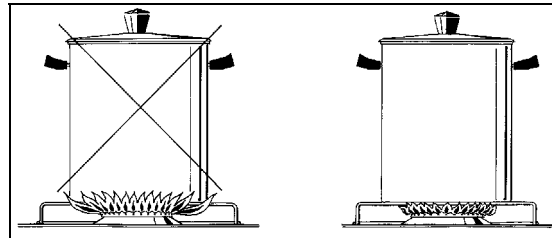

Fig. 20

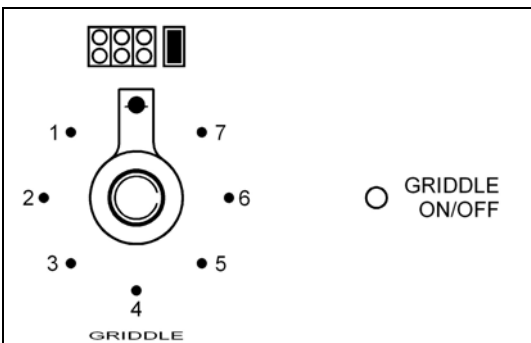

Fig. 21

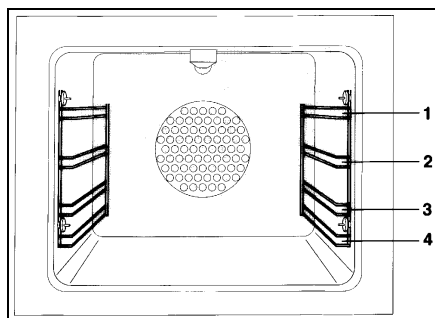

Fig. 22

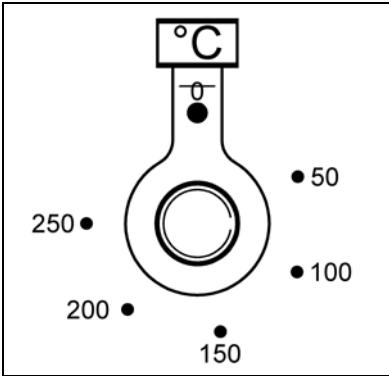

Fig 23

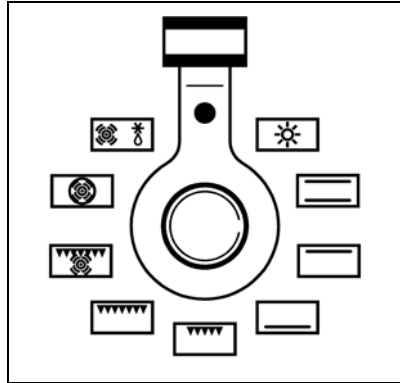

Fig. 24

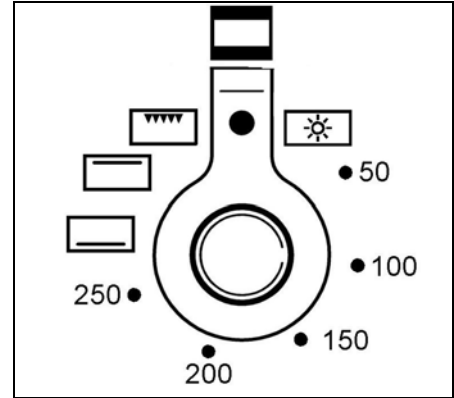

Fig. 25

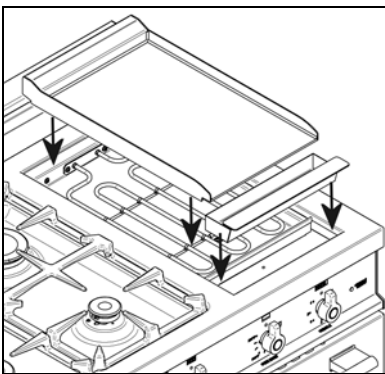

Fig. 26



Cod. 310327